



The new degree of comfort.™

Rheem Prestige™ Series Variable Speed Air Conditioners



RA20 Series

Efficiencies up to 20 SEER/13 EER

Nominal Sizes 2, 3, 4 & 5 Ton

[7.03, 10.6, 14.06 & 17.6 kW]

Cooling Capacities 17.3 to 60.5 kBTU

[5.7 to 17.7 kW]



"Proper sizing and installation of equipment is critical to achieve optimal performance. Split system air conditioners and heat pumps must be matched with appropriate coil components to meet Energy Star. Ask your Contractor for details or visit www.energystar.gov."



- **PlusOne™ Energy Efficiency** offers minimum of 20 SEER and 13 EER system performance across all capacities.
- **PlusOne™ Expanded Valve Space** – 3"-4"-5" service valve space – provides a minimum working area of 27-square inches for easier access
- **PlusOne™ Triple Service Access** – 15" wide, industry leading corner service access – makes repairs easier and faster. The two fastener removable corner allows optimal access to internal unit components. Individual louver panels come out once fastener is removed, for faster coil cleaning and easier cabinet reassembly
- **EcoNet™ Enabled product.** The EcoNet Smart Home System provides advanced air & water control for maximum energy savings and ideal comfort.
- **New composite base pan** – dampens sound, captures louver panels, eliminates corrosion and reduces number of fasteners needed
- **Powder coat paint system** – for a long lasting professional finish
- **The Copeland Scroll™ Variable Speed Compressor** has a modulating technology which provides more precise temperature control, lower humidity and greater efficiency. The over-drive feature provides cooling load up to 107°F.
- **Modern cabinet aesthetics** – increased curb appeal with visually appealing design
- **Curved louver panels** – provide ultimate coil protection, enhance cabinet strength, and increased cabinet rigidity
- **Optimized fan orifice** – optimizes airflow and reduces unit sound
- **Rust resistant screws** – confirmed through 1500-hour salt spray testing
- **Diagnostic service window** with two-fastener opening – provides access to the high and low pressure.
- **External gauge port access** – allows easy connection of "low-loss" gauge ports
- **Single-row condenser coil** (up thru 4 tons) – makes unit lighter and allows thorough coil cleaning to maintain "out of the box" performance
- **35% fewer cabinet fasteners and fastener-free base** – allow for faster access to internal components and hassle-free panel removal
- **Service trays** – hold fasteners or caps during service calls
- **QR code** – provides technical information on demand for faster service calls
- **Fan motor harness** with extra long wires allows unit top to be removed without disconnecting fan wire.
- **High and low pressure standard** on all models.

TABLE OF CONTENTS

Standard Feature	3
Available SKUs	3
Features & Benefits	4-8
Model Number Identification	9-10
General Data/Electrical Data	11
Accessories	12
Weighted Sound Power	12
Smart Home Systems	13-14
Unit Dimensions.....	15
Clearances.....	16
Wiring Diagrams	17
Refrigerant Line Size Information	18-19
Performance Data	20
Guide Specifications	21
Limited Warranty	22

Standard Feature Table

STANDARD FEATURES				
Feature	24	36	48	60
R-410A Refrigerant	√	√	√	√
Maximum SEER	20	20	20	20
Maximum EER	13	13	13	13
EcoNet Enabled	√	√	√	√
Copeland Scroll™ Variable Speed Compressor	√	√	√	√
Compressor Sound Blanket	√	√	√	√
Variable speed outdoor fan motor	√	√	√	√
Swept wing fan blade	√	√	√	√
Field Installed Filter Drier	√	√	√	√
Front Seating Service Valves	√	√	√	√
Internal Pressure Relief Valve	√	√	√	√
Internal Thermal Overload	√	√	√	√
Low Ambient capability	√	√	√	√
3-4-5 Expanded Valve Space	√	√	√	√
Composite Basepan	√	√	√	√
1" Screw Control Box Access	√	√	√	√
15" Access to Internal Components	√	√	√	√
Quick release louver panel design	√	√	√	√
No fasteners to remove along bottom	√	√	√	√
Optimized Venturi Airflow	√	√	√	√
Single row condenser coil	√	√	√	2 Row
Powder coated paint	√	√	√	√
Rust resistant screws	√	√	√	√
QR code	√	√	√	√
External gauge ports	√	√	√	√
Service trays	√	√	√	√

√ = Standard

Available SKUs

Available Models	Description
RA2024AJVCB	2 ton EcoNet™ Enabled inverter driven Rheem <i>Prestige</i> ™ Series Variable Speed Air Conditioner-208/230/1/60
RA2036AJVCB	3 ton EcoNet™ Enabled inverter driven Rheem <i>Prestige</i> ™ Series Variable Speed Air Conditioner-208/230/1/60
RA2048AJVCB	4 ton EcoNet™ Enabled inverter driven Rheem <i>Prestige</i> ™ Series Variable Speed Air Conditioner-208/230/1/60
RA2060AJVCB	5 ton EcoNet™ Enabled inverter driven Rheem <i>Prestige</i> ™ Series Variable Speed Air Conditioner-208/230/1/60

Introduction to RA20 Air Conditioner

The RA20 is our EcoNet™ Enabled, Inverter Driven *Prestige*™ Series Variable Speed Air Conditioner and is part of the Rheem Air Conditioner product line that extends from 13 to 20 SEER. This highly featured and reliable air conditioner is designed for years of reliable, efficient operation when matched with Rheem indoor aluminum evaporator coils and furnaces or air handler units with aluminum evaporators.

The EcoNet Smart Home System is an integrated system for a home's Heating, Cooling and Water Heating equipment – allowing homeowners to manage the products that consume up to 65% of their home's energy. EcoNet sets Rheem, and our distributor and contractor customers, apart in the industry with a unique, advanced and efficient technology solution.

The RA20 *Prestige*™ Series inverter driven Variable Speed Air Conditioner is exclusively designed to operate with the EcoNet™ Smart Home System. Developed by Rheem, The EcoNet Smart Home System allows homeowners to manage select high-efficiency, EcoNet Enabled air conditioners, heat pumps, gas furnaces, air handlers and water heaters from anywhere. EcoNet Enabled products in a home are connected through standard HVAC wiring; then contractors have the option of adding an EcoNet WiFi Kit (1) so the homeowner can access everything remotely through a free mobile app or mobile-friendly website. The Control Center (2) acts as both a thermostat for the heating and cooling system, and a remote control for connected water heaters.

Along with the EcoNet Smart Home System the RA20 is matched with the RHMV Constant CFM Variable Speed EcoNet Enabled Air Handler (3) or can be applied in a Furnace application with the EcoNet Enabled Two-Stage Variable Speed R802V or R96V Gas Furnaces or the fully modulating R97V and RCF Aluminum Cased Furnace Coils with EEV (4). See individual specification documents for more details of the indoor products.

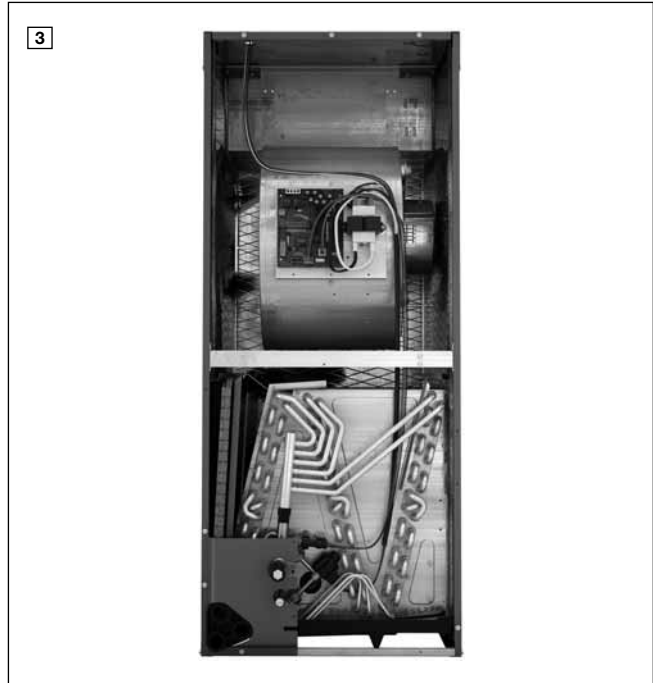



How It Works

The RA20 *Prestige*™ Series Inverter Driven Variable Speed Air Conditioner's (5) variable speed outdoor unit control (VSODU) (6) continuously monitors the EcoNet control temperature and humidity set point, suction pressure (7), suction temperature (8), outdoor coil temperature (9) and outdoor temperature (10) and feeds this information to the Copeland Inverter Control Motor Drive (11). The Copeland Inverter Control Motor Drive converts AC to DC power, sends it to the Copeland Scroll™ variable speed compressor (12) Brushless Permanent Magnet motor (BPM), dynamically adjusting its speed. Simultaneously the VSODU provides input to the ECM outdoor fan motor (13)

which is equipped with the latest swept wing fan technology (14) and the Electronic Expansion Valve (EEV) (15) which syncs up with the compressor speed to deliver the exact capacity the home needs to meet its comfort requirements. The result of this advanced technology is significantly improved energy efficiency and comfort. Energy efficiency is improved by precise load matching, less cycling on and off and low amp gradual compressor, outdoor and indoor motor operation. Comfort is improved by precise temperature control, precise humidity control and extra capacity during extreme summer and cold weather conditions.

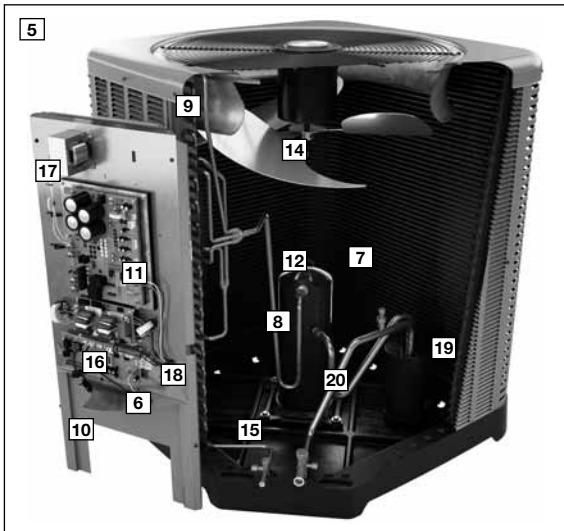

System Component Descriptions

EcoNet Control Center – (2): The EcoNet Control Center serves as the hub of communication for a home’s Heating, Cooling and Water Heating systems and is required to operate an EcoNet Enabled Heating and Cooling system in a fully communicating mode. The EcoNet Control center displays detail diagnostic from outdoor and indoor connected units. See individual specification documents for more details of the EcoNet Control Center.

EcoNet Cooling and Heating WiFi Module – (1) is required to remotely operate an EcoNet Enabled Heating and Cooling system from the EcoNet web portal and mobile apps. See individual specification documents for more details of the EcoNet Control Center.

Variable Speed Outdoor Unit Control (VSODU) – (6) is where control wiring is hooked to the RA20. The VSODU control takes input from the EcoNet Control Center, outdoor suction temperature and pressure sensors, outdoor air temperature and communicates to the Copeland Inverter Control Motor Drive, EEV, outdoor fan and indoor blower to precisely control system capacity output of the air conditioner cooling mode. It also is equipped with Dual Seven-Segment Display for technician interface, operation status and fault code communication. Two momentary buttons allow technician to initiate various operating modes. Various LED’s communicate active EcoNet communication, microprocessor activity and EEV operation. See I&O for more details.

The Copeland Inverter Control Motor Drive – (11) converts incoming single-phase AC power to 3 phase DC simulated sine wave power. Once power is converted the Copeland Inverter Control Motor Drive varies frequency of the power to the compressor varying the compressor speed. The Copeland Inverter Control Motor Drive has active protection algorithms that keep the compressor safely inside its operating envelope.

The Copeland Scroll™ Variable Speed compressor – (12) utilizes a Brushless Permanent Magnet Motor (BPM) that varies the Scroll speed, thus, varying the refrigerant flow. The robust scroll design has proven reliability over competing compressor technologies.

Swept Wing Fan Blade – (14) is the latest technology in outdoor fans that increase efficiency and reduces air noise.

The Electronic Expansion Valve (EEV) – (Located on the indoor coil) is an electronically driven refrigerant control valve. A small stepper motor is used to open and close the valve to precisely control refrigerant flow. It is controlled by the EcoNet Air Handler Control or stand alone EEV Control in furnace coil applications. Either control receives input from the pressure transducer and suction sensor to control the refrigerant in the cooling mode. The EEV is superior to a TXV (thermostatic expansion valve) because the EEV controls superheat at the evaporator coil under varying load and refrigerant flow conditions, more precisely than traditional TXV’s.

The Filter – (16) is an electrical device that “cleans” the AC power component. This low pass filter only permits the passage of 60-Hertz signal to the inverter drive.

The Pressure Transducer – (7) is used to measure suction pressure in the outdoor air conditioner. The VSODU takes this input to operate low pressure and make decisions on system operation such as low ambient cooling.

Various temperature sensors – There is an outdoor air sensor (10), an outdoor coil sensor (9), a discharge line temperature sensor (not shown, located on discharge line), a suction line temperature sensor (8) and a compressor sump temperature sensor (not shown, located bottom of compressor). The VSODU uses these temperature measurements to operate the system.

The Choke – (17) is provided to absorb power spikes that might occur on the DC line.

Ferrite Rings – (18) are iron cores through which AC power is looped keeping any electrical noise contained. They also reduce the induction of electrical transient into the DC drive.

The Suction Accumulator – (19) prevents liquid refrigerant from entering the compressor.

Features

In addition all RA20 *Prestige*™ Series inverter driven Variable Speed Air Conditioners have the following features:



Our unique composite base (3) reduces sound emission, eliminates rattles, significantly reduces fasteners, eliminates corrosion and has integrated brass compressor attachment inserts (4). Furthermore it has incorporated into the design, water management features, means for hand placement (5) for unit maneuvering, screw trays (6) and inserts for lifting off unit pad. (7)

Service Valves (8) are rigidly mounted in the composite base with 3" between suction and discharge valves, 4" clearance below service valves and a minimum of 5" above the service valves, creating industry leading ease of installation. The minimum

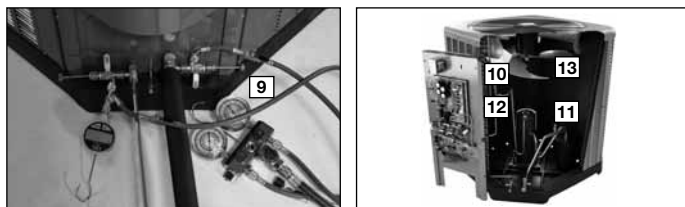

27 square-inches around the service valves allows ample room to remove service valve schrader prior to brazing, plenty of clearance for easy brazing of the suction and discharge lines to service valve outlets, easy access and hookup of low loss refrigerant gauges (9), and access to the service valve caps for opening.

Controls are accessed from the corner of the unit by removing only one fastener from the control access cover, revealing the industry's largest 15" wide and 22" tall control area (10). With all this room in the control area the high voltage electrical whip (11) can easily be inserted through the right size opening in the bottom of the control area. Routing it leads directly to lugs for connection. The low voltage control wires (12) are easily connected to the units VSODU terminal strip. The service window (14) can be removed by removing two screws to view the interior of unit. (15) (High and low pressure is standard on RA20 models). If in the rare event, greater access is needed to internal compo-

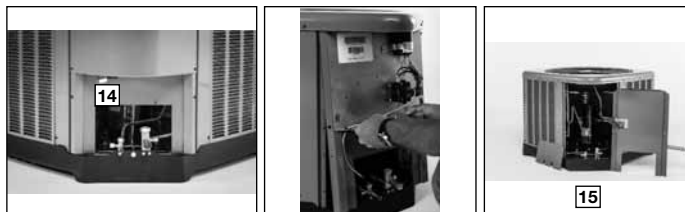

nents, such as the compressor, the entire corner of the unit can be removed along with the top cover assembly to have unprecedented access to interior of the unit (16). Extra wire length is incorporated into each outdoor fan and compressor so top cover and control panel can be positioned next to the unit. Or with minimal effort the plug can be removed from the compressor and the outdoor fan wires can be removed from the VSODU to allow even more uncluttered access to the interior of the unit

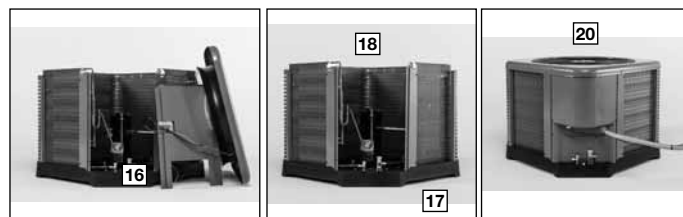

(17). Outdoor coil heights range from as short as 35" to 48". Disassembly to this degree and complete reassembly only takes a first time service technician less than 10 minutes. (17)

All units utilize formed louver panels which provide industry leading coil protection. Louver removal for coil cleaning is accomplished by removing one screw and lifting the panel out of the composite base pan. (19) All RA20 2, 3, 4 ton units utilize single row coils (18) making cleaning easy and complete, restoring the performance of the air conditioner back to out of the box performance levels year after year.

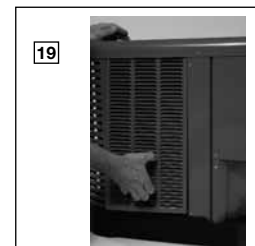

The outdoor fan motor has sleeve bearings and is inherently protected. The motor is totally enclosed for maximum protection from weather, dust and corrosion. (20) Access to the outdoor fan is made by removing four fasteners from the fan grille. The outdoor fan can be removed from the fan grille by removing 4 fasteners in the rare case outdoor fan motor fails.

Each cabinet has optimized composite (21) fan orifice assuring efficient and quiet airflow.



The entire cabinet has post powder paint (22) achieving 1000 hour salt spray rating, allowing the cabinet to retain its aesthetics throughout its life.

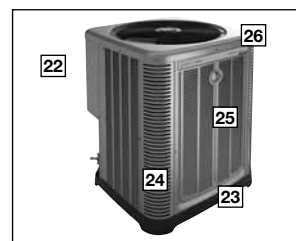

The Copeland Scroll™ Variable Speed compressors with standard internal pressure relief and internal thermal overload are used on all capacities assuring longevity of high efficient and quiet operation for the life of the product. All RA20 Air Conditioner come standard with high and low pressure switches reinforced vinyl compressor sound covers containing a 1 1/2 inch thick batt of fiberglass insulation and open edges are sealed with a 1 inch wide hook and loop fastening tape for superior sound quality.

Features (con't.)

Each unit is shipped with filter drier for field installation and will trap any moisture or dirt that could contaminate the refrigerant system.



All cabinets have industry leading structural strength due to the composite base pan (23), interlocking corner post (24), formed curved louver panels (25) and drawn top cover (26) making it the most durable cabinet on the market today.

Each RA20 capacity has undergone rigorous psychometric testing to assure performance ratings of capacity, SEER and EER per AHRI Standard 210/240 rating conditions. Also each unit bears the UL mark and each unit is certified to UL 1995 safety standards.



Each unit has undergone specific strain and modal testing to assure tubing (27) is outside the units natural frequency and that the suction and discharge lines connected to the compressor withstand any starting, steady state operation, or shut down forces imposed by the compressor.

All units have been sound tested in sound chamber to AHRI 270 rating conditions, and A-weighted Sound Power Level tables produced, assuring units have acceptable noise qualities (see page 12). Each unit has been ran in cooling operation at 95°F and sound ratings for the RA20 range from as low as 68 dBA at low speed and as high as 76 dBA at 95°F rated conditions.

All units have been ship tested to assure units meet stringent “over the road” shipping conditions.

As manufactured, all units in the RA20 family have cooling capability to 40°F. Addition of low ambient control will allow the unit to operate down to 0°F. Factory testing is performed on each unit. All component parts meet well defined specification and continually go through receiving inspections. Each component installed on a unit is scanned, assuring correct component utilization for a given unit capacity and voltage. All condenser coils are leak tested with pressurization test to 550#’s and once installed and assembled, each units’ complete refrigerant system is helium leak tested. All units are fully charged from the factory for up to 15 feet of piping. All units are factory run tested. The RA20 has a 10-year conditional unit replacement warranty (registration required) and a 10 year limited parts warranty.

Optional Accessories

(Refer to accessory chart for model #)

3"/6"/12"

- Gray high density polyethylene feet are available to raise unit off of mounting surface away from moisture

Accessories

EcoNet Control Center



RETST601SYS

The EcoNet Control Center serves as the hub of communication for a home’s Heating, Cooling and Water Heating systems, and is required to operate an EcoNet Enabled Heating & Cooling system in a fully communicating mode.

WiFi Kit for Heating and Cooling Systems



REWRA630SYS

The WiFi kit is required to remotely operate EcoNet Enabled Heating and Cooling Systems from the EcoNet Web portal and mobile apps.

Thermostat Kit - RXHT-A02

Air Conditioners*

R	A	20	24	A	J	V	C	B	*
Brand	Product Category	SEER	Capacity BTU/HR	Major Series*	Voltage	Type	Controls	Minor Series**	Option Code
Rheem	A - Air Conditioners	13 - 13 SEER 14 - 14 SEER 16 - 16 SEER 17 - 17 SEER 20 - 20 SEER	18 - 18,000 [5.28 kW] 24 - 24,000 [7.03 kW] 30 - 30,000 [8.79 kW] 36 - 36,000 [10.55 kW] 42 - 42,000 [12.31 kW] 48 - 48,000 [14.07 kW] 60 - 60,000 [17.58 kW]	A - 1st Design B - 2nd Design	J - 1ph, 208-230/60 C - 3ph, 208-230/60	1 - Single-stage 2 - Two-stage V - Inverter	C - Communicating N - Non-Communicating	B - High and low pressure control	N/A

*See page 3 for available SKU's.

†Two-stage and inverter available in whole capacities only.

Heat Pumps (For Reference)**

R	P	20	24	A	J	V	C	A	*
Brand	Product Category	SEER	Capacity BTU/HR	Major Series*	Voltage	Type	Controls	Minor Series**	Option Code
Rheem	P - Heat Pump	13 - 13 SEER 14 - 14 SEER 15 - 15 SEER 17 - 17 SEER 20 - 20 SEER	18 - 18,000 [5.28 kW] 24 - 24,000 [7.03 kW] 30 - 30,000 [8.79 kW] 36 - 36,000 [10.55 kW] 42 - 42,000 [12.31 kW] 48 - 48,000 [14.07 kW] 60 - 60,000 [17.58 kW]	A - 1st Design	J - 1ph, 208-230/60 C - 3ph, 208-230/60 D - 3ph, 460/60	1 - Single-stage 2 - Two-stage V - Inverter P - Piston	C - Communicating N - Non-Communicating	A - 1st Design	N/A

†Two-stage and inverter available in whole capacities only.

Furnace Coils (For Reference)**

R	C	F	24	17	S	E	A	M	C	A	*
Brand	Product Category	Type	Capacity BTU/HR	Width	Efficiency	Metering Device	Major Series*	Orientation	Casing	Minor Series**	Option Code
Rheem	C - Evap Coil F - Furn Coil H - Air-Handler Coil	F - Furn Coil H - Air-Handler Coil	24 - 24,000 [7.03 kW] 36 - 36,000 [10.55 kW] 48 - 48,000 [14.07 kW] 60 - 60,000 [17.58 kW]	14 - 14" 17 - 17.5" 21 - 21" 24 - 24.5"	S - Standard Eff. M - Mid Eff. H - High Eff.	T-TXV E-EEV P-Piston	A - 1st Design	M - Multipoise V - Vertical only/ convertible H - Ded. Horizontal only	C - Cased U - Uncased	A - 1st Design	N/A

NOTE: The above Model Number ID's are for reference only. Available SKU's are listed on the standard features/available SKU page of model spec sheet.

[] Designates Metric Conversions



Air

Model Number Identification
RA20 Series



INTEGRATED HOME COMFORT



Air

Model Number Identification
RA20 Series**90%+ AFUE Gas Furnaces (For Reference)****

R	96	V	A	70	2	3	17	M	S	A
Brand	Series	Motor	Major Rev	Input BTU/HR	Stages	Air Flow	Cabinet Width	Configuration	Nox	Minor Rev
Rheem	90 - 90 AFUE	V - Variable speed	A - 1st Design	040 - 42,000 [12.31 kW]	1 - Single-stage	3 - up to 3 ton	14 - 14"	M - Multi	X - Low Nox	A - 1st Design
	92 - 92 AFUE	T - Constant Torque (X-13)		060 - 56,000 [16.41 kW]	2 - Two-stage	5 - 3 1/2 up to 5 ton	17 - 17.5"		S - Standard	
	95 - 95 AFUE			070 - 70,000 [20.51 kW]	M - Modulating		21 - 21"			
	96 - 96 AFUE			085 - 84,000 [24.62 kW]			24 - 24.5"			
	97 - 97 AFUE	P - PSC		100 - 98,000 [28.72 kW]						
				115 - 112,000 [32.82 kW]						

80% AFUE Gas Furnaces (For Reference)**

R	80	2	V	A	075	3	17	M	S	A
Brand	Series	Stages	Motor	Major Rev	Input BTU/HR	Air Flow	Cabinet Width	Configuration	Nox	Minor Rev
Rheem	80 - 80+ AFUE	1 - Single-stage	V - Variable speed	A - 1st Design	050 - 50,000 [15 kW]	3 - up to 3 ton	14 - 14"	M - Multi	X - Low Nox	A - 1st Design
		2 - Two-stage	T - Constant Torque (X-13)		075 - 75,000 [22 kW]	4 - 2 1/2 to 4 ton	17 - 17.5"	D - Down	S - Standard	
			P - PSC premium		100 - 100,000 [29 kW]	5 - 3 1/2 up to 5 ton	21 - 21"	Z - Down & zero clearance down flow		
			S - PSC standard		125 - 125,000 [37 kW]		24 - 24.5"			
					150 - 150,000 [44 kW]					

Air Handlers (For Reference)**

R	H	M	V	36	17	S	E	A	C	J	A	000	*	-
Brand	Product Category	Stages of Airflow	Motor Type	Capacity BTU/HR	Width	Coil Size	Metering Device	Major Series*	Controls	Voltage	Minor Series**	Factory Heat Cap	Option Code	
Rheem	H - Air Handler	1 - Single-Stage	V - Variable Speed	24 - 24,000 [7.03 kW]	14 - 14"	S - Standard Eff.	T - TEV	A - 1st Design	C - Communicating	J - 1ph, 208-240/60	A - 1st Design	00 - no factory heat with option code	*TBD	
		2 - Two-Stage	T - Constant Torque	36 - 36,000 [10.55 kW]	17 - 17.5"	M - Mid Eff.	E - EEV	N - Non-comm	N - Non-comm					
		M - Modulating	P - PSC	48 - 48,000 [14.07 kW]	21 - 21"	H - High Eff.	P - Piston							
				60 - 60,000 [17.58 kW]	24 - 24.5"									

NOTE: The above Model Number ID's are for reference only. Available SKU's are listed on the standard features/available SKU page of model spec sheet.

[J] Designates Metric Conversions

Physical Data				
Model No.	RA2024A	RA2036A	RA2048A	RA2060A
Nominal Tonnage	2.0	3.0	4.0	5.0
Valve Connections				
Liquid Line O.D. – in.	3/8	3/8	3/8	3/8
Suction Line O.D. – in.	3/4	3/4	7/8	7/8
Refrigerant (R-410A) furnished oz. ¹	148	193.6	196	376
Compressor Type	Scroll			
Outdoor Coil				
Net face area – Outer Coil	22.2	22.3	32.5	32.5
Net face area – Inner Coil	—	—	—	—
Tube diameter – in.	3/8	3/8	3/8	3/8
Number of rows	1	1	1	2
Fins per inch	20	20	22	20
Outdoor Fan				
Diameter – in.	24	24	26	26
Number of blades	3	3	3	3
Motor hp	1/5	1/3	1/2	1/2
CFM	3330	4315	6240	6175
RPM	772	825	935	900
watts	83	114	278	278
Shipping weight – lbs.	226	244	263	316
Operating weight – lbs.	214	236	255	308
Electrical Data				
Line Voltage Data (Volts-Phase-Hz)	208/230-1-60	208/230-1-60	208/230-1-60	208/230-1-60
Maximum overcurrent protection (amps)²	35	45	70	80
Minimum circuit ampacity³	21	29	46	48
Compressor				
Rated load amps	15	20.1	32	34.1
Locked rotor amps	35	35	50	50
Condenser Fan Motor				
Full load amps	1.4	3.5	5.3	5.3
Locked rotor amps	N/A	N/A	N/A	N/A

¹Refrigerant charge sufficient for 15 ft. length of refrigerant lines. For longer line set requirements see the installation instructions for information about set length and additional refrigerant charge required.

²HACR type circuit breaker or fuse.

³Refer to National Electrical Code manual to determine wire, fuse and disconnect size requirements.

Accessories

Model No.	RA2024	RA2036	RA2048	RA2060
EcoNet Control Center	RETST601SYS	RETST601SYS	RETST601SYS	RETST601SYS
WiFi Kit for Heating & Cooling	REWRA630SYS	REWRA630SYS	REWRA630SYS	REWRA630SYS
Compressor sound cover	STD	STD	STD	STD
Heat pump Riser 6 in.	686020	686020	686020	686020

Weighted Sound Power Level (dBA)

VS ODU	Stage	Standard Rating (dBA)	TYPICAL OCTAVE BAND SPECTRUM (dBA without tone adjustment)						
			125	250	500	1000	2000	4000	8000
(-)A2024	High	68	47.1	47.7	58.8	57.1	55.0	52.7	45.6
	Low	58.9	29	36.5	42	45.7	42.3	43.2	33
(-)A2036	High	72	42.9	52.8	62.7	63.6	58.7	54.1	52.4
	Low	57	29.2	36.7	44.9	45.4	42.2	39.4	32.2
(-)A2048	High	72	48.2	55.3	64.6	61.7	56.2	51.7	46.2
	Low	54	30.6	39	42.2	42.5	36.5	35.2	35
(-)A2060	High	76	50.7	62.7	67.7	65.4	64.2	59.2	54.9
	Low	70	46.6	50.5	62.7	52.9	49.4	46	41.4

NOTE: Tested in accordance with AHRI Standard 270-08 (not listed in AHRI)

Integrated Controls



EcoNet is smart, new technology developed exclusively by Rheem that allows Heating, Cooling, and Water Heating products to communicate with each other on one integrated network.

Easy to Setup, Easy to Use, Easy to Save

- Built with our 360°+1 design philosophy, it is optimized for Installability™, Performance, Integration & Serviceability
- Controls 65%† or more of a typical home’s energy use from a single device
- Can reduce energy costs by up to 30%††

Features

- Added support for new EEV (Electronic Expansion Valve) Air Handlers, Air Conditioners and Heat Pumps*
- Rapid installation with standard 4-wire configuration
- Automatically configures communicating equipment with optimal settings
- Adapts to home décor through interchangeable faceplates and adjustable background coloring
- Full-color, 4.7" LCD touchscreen display with easy-to-read icons and text
- Convenient date, time and indoor/outdoor temperature indications
- 5 operating modes with short-cycle protection (Heat, Cool, Auto, Emergency Heat, Fan Only)

- 7-Day programmable schedule with Smooth Arrival & Whole Home Vacation options
- Detailed operating status, alarm history, and audible alerts
- Supports humidifier accessories or over-cool based dehumidification
- One-touch access to Water Heater Management†††
- Easily manage from anywhere in the world with the compatible WiFi Module & EcoNet app for smart phones and tablets

Warranty

- 5-Year limited warranty from date of installation
 - † Source – Department of Energy
 - †† When compared to non-programmable thermostats. Source: ENERGY STAR® for Programmable Thermostats
 - ††† Requires wired connection to EcoNet Enabled Electric or Hybrid Water Heaters



EcoNet™ Control Center

Home control with intuitive LCD touchscreen navigation

RETST601SYS

EcoNet Control Center Compatibility

OFFERINGS	HEATING & COOLING												WiFi Kit for HVAC REWRA630SYS	WATER HEATING		
	Gas Furnaces			Air Handlers		Air Conditioners				Heat Pumps				Electric Tank Models Ending in EC2	Hybrid Tank HB50 Models	Gas Powered Damper Tank Models
Models	R97V	R96V	R802V	RHMV*	RH2T (EEV**)	RA20*	RASL-JEC	RA17	RARL-JEC	RP20*	RP17*	RPRL-JEC				
RETST601SYS	✓	✓	✓	✓	✓	✓	✓★	✓	✓★	✓	✓	✓★	✓	✓	✓	

*Available in 2016

**Electronic Expansion Valve (EEV) Models

★ Comfort Control² System™ Translator for EcoNet Required

Installation of the RETRN620CC2 Comfort Control² System™ Translator on the outdoor unit’s control board is required to operate Comfort Control² System™ Air Conditioner and Heat Pump models (****-JEC) with an EcoNet Control Center in a fully communicating mode when matched with EcoNet Enabled Furnaces or Air Handlers*.



The EcoNet™ WiFi Kit for Heating & Cooling Systems (REWRA630SYS) provides remote control of EcoNet Enabled air and water products from smart phones, tablets, and personal computers using the home's internet connection.

Features

- Enables remote operation from:
 - The EcoNet App on Apple® mobile devices (iPhone®, iPad®, & iPod® Touch) using iOS version 7.0 or later
 - The EcoNet App on Android™ based smart phones and tablets using Android™ version 4.4 or later
 - Recent versions of popular web browsers such as Internet Explorer, Chrome, Safari, etc.
- Designed for use with EcoNet communicating HVAC Systems
- Compatible with 802.11 b/g/n WiFi networks
- WPA-2 Security using AES/CCMP
- Status LEDs:
 - Power & Equipment Connection Status
 - Home Network WiFi Status
 - Internet Connection Status
- "WLAN SETUP" factory reset button

- 24" Port-to-Port Connection Cable
- 1" x 2" Double Adhesive Mounting Tape
- RJ12 Y Splitter (for use with communicating electric water heaters)

Compatibility

- Works with any HVAC System which includes an EcoNet Enabled furnace or air handler and an EcoNet control center.

Warranty

- 1 Year from installation date



EcoNet WiFi Kit for Heating & Cooling Systems

REWRA630SYS

WiFi Kit Components

- EcoNet WiFi Module
- Installation Instructions
- V Power Adapter
- Junction Box

HVAC Connection Illustration

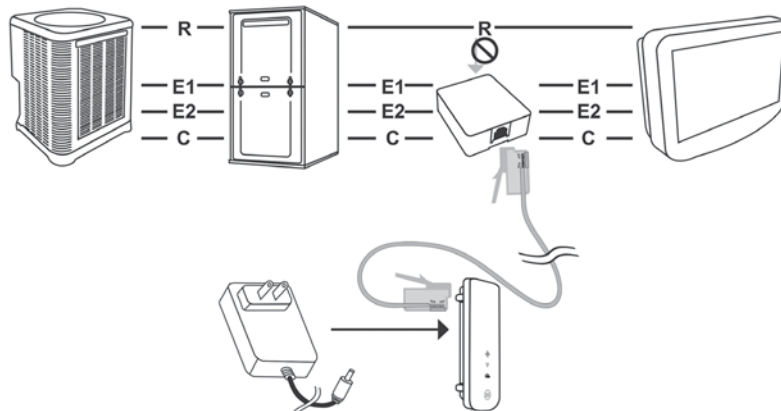

Unit Dimensions

MODEL NO.	OPERATING						SHIPPING					
	H (Height)		L (Length)		W (Width)		H (Height)		L (Length)		W (Width)	
	INCHES	mm	INCHES	mm	INCHES	mm	INCHES	mm	INCHES	mm	INCHES	mm
RA2024	39	990	33.75	857	33.75	857	41.56	1055	37.64	956	37.56	954
RA2036	39	990	33.75	857	33.75	857	41.56	1055	37.64	956	37.56	954
RA2048	51	1295	35.75	908	35.75	908	53.56	1360	39.37	999	39.64	1006
RA2060	51	1295	35.75	908	35.75	908	53.56	1360	39.37	999	39.64	1006

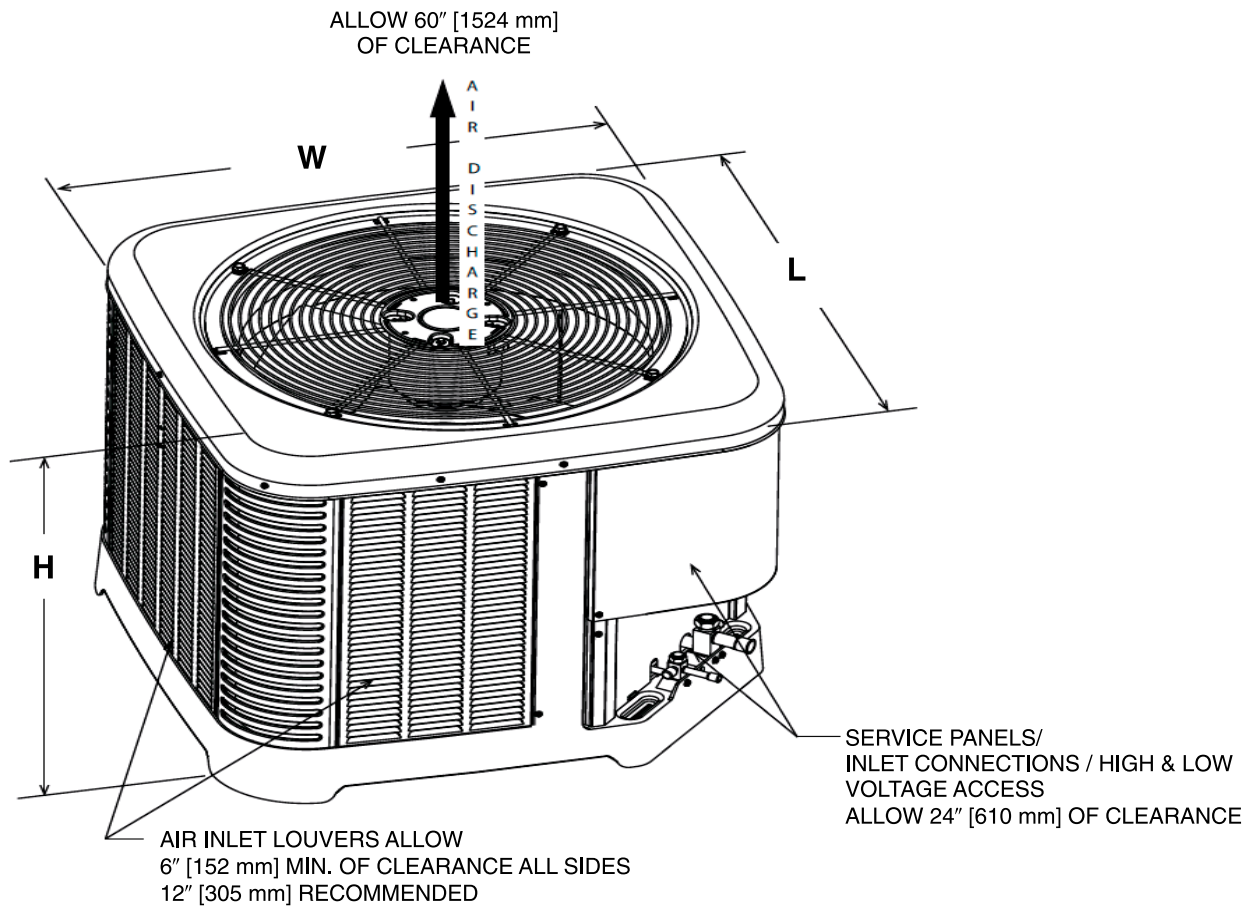

[] Designates Metric Conversions

ST-A1226-02-00



CLEARANCES

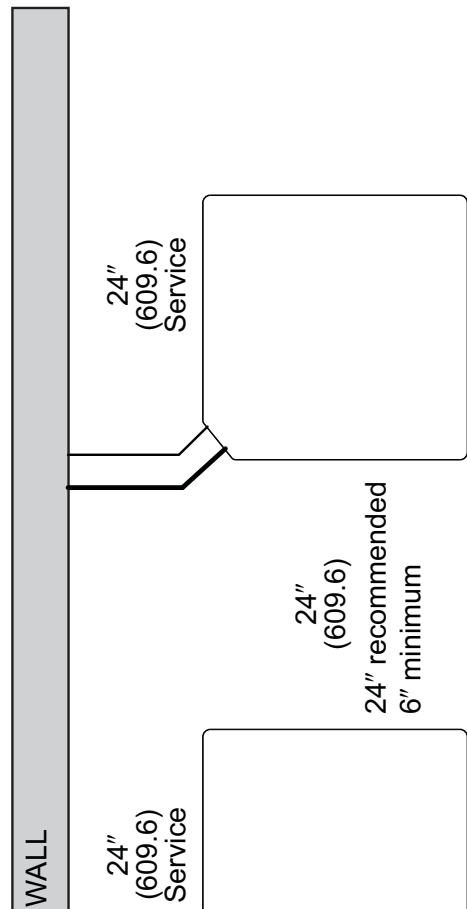
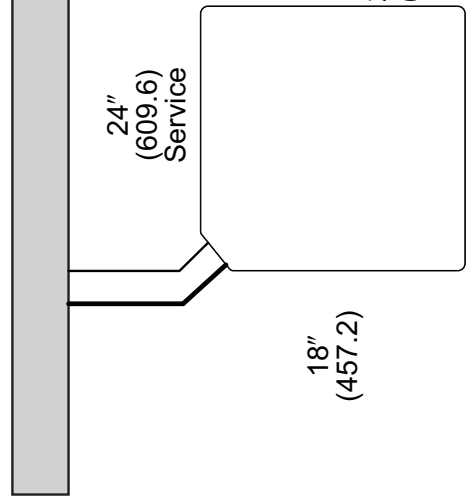
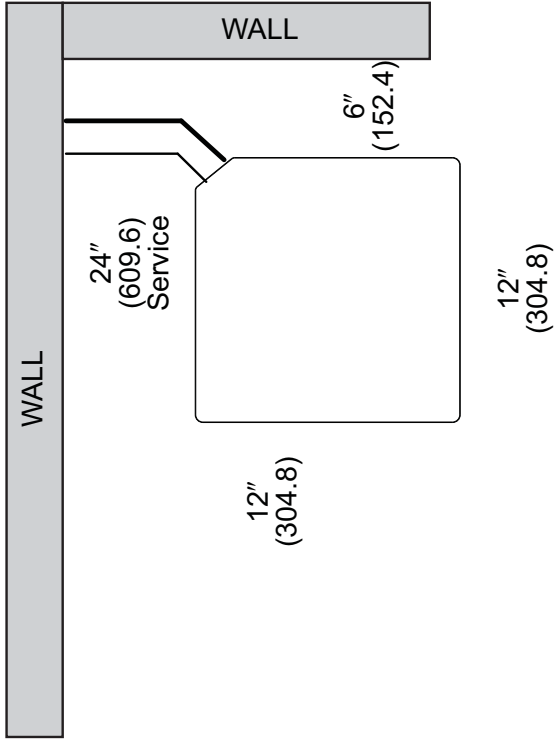
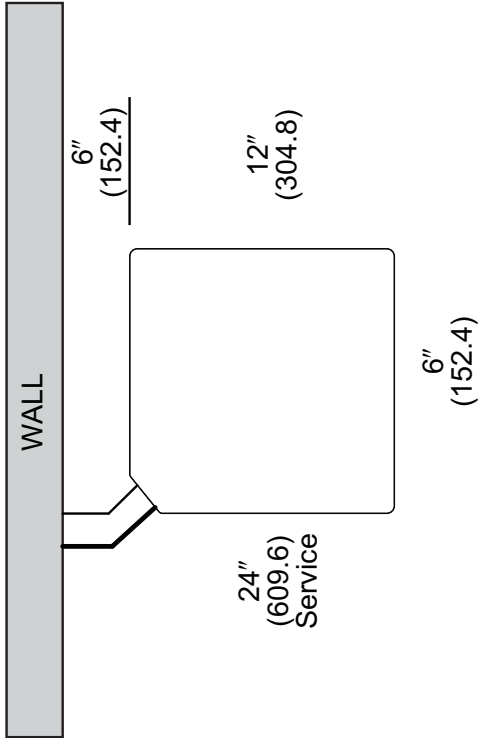

NOTE: NUMBERS IN () = mm

IMPORTANT: When installing multiple units in an alcove, roof well or partially enclosed area, ensure there is adequate ventilation to prevent re-circulation of discharge air.



Control Wiring

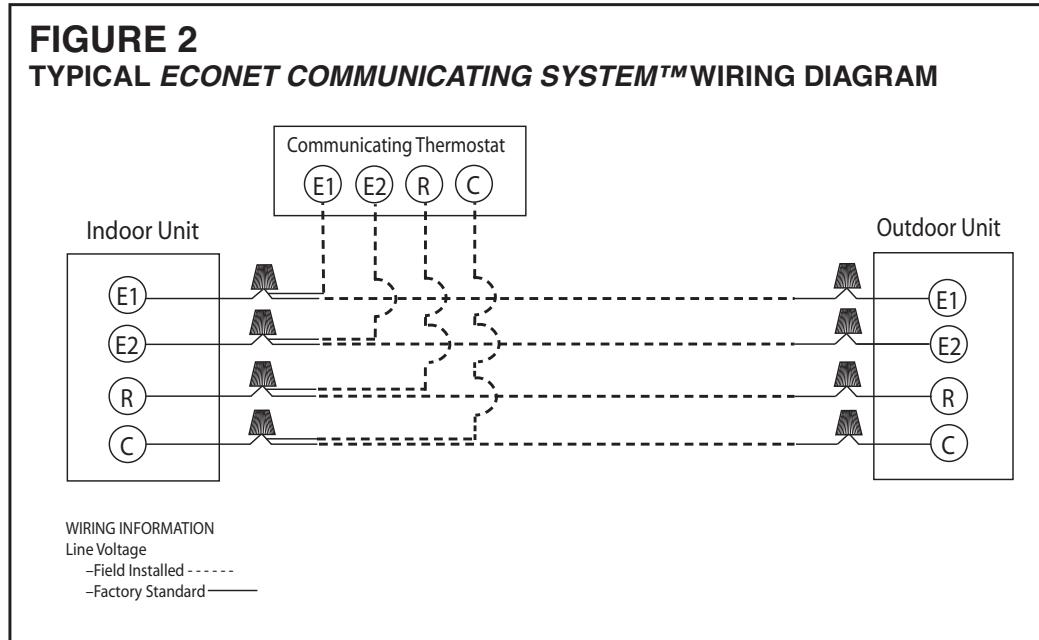

Application Guidelines

1. Intended for outdoor installation with free air inlet and outlet. Outdoor fan external static pressure available is less than 0.01 -in. wc.
2. Minimum outdoor operation air temperature for cooling mode without low-ambient operation accessory is 55°F (12.8°C).
3. Maximum outdoor operating air temperature is 125°F (51.7°C).
4. For reliable operation, unit should be level in all horizontal planes.
5. Use only copper wire for electric connections at unit. Aluminum and clad aluminum are not acceptable for the type of connector provided.
6. Do not apply capillary tube indoor coils to these units.
7. Factory – supplied filter drier must be installed.

Refrigerant Line Size Information

R-410A System Capacity Model	Liquid Line Size Connection Size (Inch I.D.) (mm)	Liquid Line Size (Inch O.D.) (mm)	Liquid Line Selection Chart																	
			Elevation (Above or Below) Indoor Coil Total Equivalent Length - Feet [m]																	
			25 [7.62]	50 [15.24]	75 [22.86]	100 [30.48]	125 [45.72]	150 [45.72]	175 [53.34]	200 [60.96]	225 [68.58]	250 [76.20]	275 [83.82]	300 [91.44]	N/R	N/R	N/R	N/R		
24	3/8" [9.53]	1/4 [6.35]	50 [15.24]	35 [10.67]	15 [4.57]	N/R	N/R	N/R	N/R	N/R	N/R	N/R	N/R	N/R	N/R	N/R	N/R	N/R		
		5/16 [7.94]	50 [15.24]	75 [22.86]	80 [24.38]	75 [22.86]	70 [21.34]	60 [18.29]	55 [16.76]	50 [15.24]	45 [13.72]	40 [12.19]	35 [10.67]	N/R	N/R	N/R	N/R	N/R		
		3/8 [9.53]	50 [15.24]	75 [22.86]	95 [28.96]	90 [27.43]	90 [27.43]	90 [27.43]	85 [25.91]	85 [25.91]	80 [24.38]	80 [24.38]	80 [24.38]	80 [24.38]	80 [24.38]	80 [24.38]	80 [24.38]	80 [24.38]	80 [24.38]	80 [24.38]
		7/16 [11.12]	50 [15.24]	75 [22.86]	100 [30.48]	100 [30.48]	95 [28.96]	95 [28.96]	95 [28.96]	95 [28.96]	95 [28.96]	95 [28.96]	95 [28.96]	95 [28.96]	95 [28.96]	95 [28.96]	95 [28.96]	95 [28.96]	95 [28.96]	95 [28.96]
		1/2 [12.71]	50 [15.24]	75 [22.86]	100 [30.48]	100 [30.48]	100 [30.48]	100 [30.48]	100 [30.48]	100 [30.48]	100 [30.48]	100 [30.48]	100 [30.48]	100 [30.48]	100 [30.48]	100 [30.48]	100 [30.48]	100 [30.48]	100 [30.48]	100 [30.48]
		1/4 [6.35]	N/R	N/R	N/R	N/R	N/R	N/R	N/R	N/R	N/R	N/R	N/R	N/R	N/R	N/R	N/R	N/R	N/R	N/R
36	3/8" [9.53]	5/16 [7.94]	50 [15.24]	60 [18.29]	45 [13.72]	30 [9.14]	20 [6.1]	5 [1.52]	N/R	N/R	N/R	N/R	N/R	N/R	N/R	N/R	N/R	N/R		
		3/8 [9.53]	50 [15.24]	75 [22.86]	80 [24.38]	75 [22.86]	70 [21.34]	65 [19.81]	60 [18.29]	55 [16.76]	50 [15.24]	50 [15.24]	50 [15.24]	50 [15.24]	50 [15.24]	50 [15.24]	50 [15.24]	50 [15.24]	50 [15.24]	
		7/16 [11.12]	50 [15.24]	75 [22.86]	90 [27.43]	90 [27.43]	85 [25.91]	85 [25.91]	80 [24.38]	80 [24.38]	80 [24.38]	80 [24.38]	80 [24.38]	80 [24.38]	80 [24.38]	80 [24.38]	80 [24.38]	80 [24.38]	80 [24.38]	80 [24.38]
		1/2 [12.71]	50 [15.24]	75 [22.86]	95 [28.96]	95 [28.96]	95 [28.96]	90 [27.43]	90 [27.43]	90 [27.43]	90 [27.43]	90 [27.43]	90 [27.43]	90 [27.43]	90 [27.43]	90 [27.43]	90 [27.43]	90 [27.43]	90 [27.43]	90 [27.43]
		1/4 [6.35]	N/R	N/R	N/R	N/R	N/R	N/R	N/R	N/R	N/R	N/R	N/R	N/R	N/R	N/R	N/R	N/R	N/R	N/R
		5/16 [7.94]	50 [15.24]	35 [10.67]	20 [6.1]	N/R	N/R	N/R	N/R	N/R	N/R	N/R	N/R	N/R	N/R	N/R	N/R	N/R	N/R	N/R
48	3/8" [9.53]	3/8 [9.53]	50 [15.24]	70 [21.34]	65 [19.81]	60 [18.29]	55 [16.76]	50 [15.24]	40 [12.19]	35 [10.67]	30 [9.14]	25 [7.62]	20 [6.1]	N/R	N/R	N/R	N/R	N/R		
		7/16 [11.12]	50 [15.24]	75 [22.86]	80 [24.38]	75 [22.86]	70 [21.34]	70 [21.34]	70 [21.34]	70 [21.34]	70 [21.34]	70 [21.34]	70 [21.34]	70 [21.34]	70 [21.34]	70 [21.34]	70 [21.34]	70 [21.34]	70 [21.34]	70 [21.34]
		1/2 [12.71]	50 [15.24]	75 [22.86]	85 [25.91]	85 [25.91]	80 [24.38]	80 [24.38]	80 [24.38]	80 [24.38]	80 [24.38]	80 [24.38]	80 [24.38]	80 [24.38]	80 [24.38]	80 [24.38]	80 [24.38]	80 [24.38]	80 [24.38]	80 [24.38]
		1/4 [6.35]	N/R	N/R	N/R	N/R	N/R	N/R	N/R	N/R	N/R	N/R	N/R	N/R	N/R	N/R	N/R	N/R	N/R	N/R
		5/16 [7.94]	50 [15.24]	35 [10.67]	20 [6.1]	N/R	N/R	N/R	N/R	N/R	N/R	N/R	N/R	N/R	N/R	N/R	N/R	N/R	N/R	N/R
		3/8 [9.53]	50 [15.24]	70 [21.34]	65 [19.81]	60 [18.29]	55 [16.76]	50 [15.24]	40 [12.19]	35 [10.67]	30 [9.14]	25 [7.62]	20 [6.1]	N/R	N/R	N/R	N/R	N/R	N/R	N/R
60	3/8" [9.53]	7/16 [11.12]	50 [15.24]	75 [22.86]	80 [24.38]	75 [22.86]	70 [21.34]	70 [21.34]	70 [21.34]	70 [21.34]	70 [21.34]	70 [21.34]	70 [21.34]	70 [21.34]	70 [21.34]	70 [21.34]	70 [21.34]	70 [21.34]	70 [21.34]	
		1/2 [12.71]	50 [15.24]	75 [22.86]	85 [25.91]	85 [25.91]	80 [24.38]	80 [24.38]	80 [24.38]	80 [24.38]	80 [24.38]	80 [24.38]	80 [24.38]	80 [24.38]	80 [24.38]	80 [24.38]	80 [24.38]	80 [24.38]	80 [24.38]	80 [24.38]
		1/4 [6.35]	N/R	N/R	N/R	N/R	N/R	N/R	N/R	N/R	N/R	N/R	N/R	N/R	N/R	N/R	N/R	N/R	N/R	N/R
		5/16 [7.94]	10 [3.05]	N/R	N/R	N/R	N/R	N/R	N/R	N/R	N/R	N/R	N/R	N/R	N/R	N/R	N/R	N/R	N/R	N/R
		3/8 [9.53]	50 [15.24]	40 [12.19]	30 [9.14]	20 [6.1]	10 [3.05]	N/R	N/R	N/R	N/R	N/R	N/R	N/R	N/R	N/R	N/R	N/R	N/R	N/R
		7/16 [11.12]	50 [15.24]	60 [18.29]	55 [16.76]	50 [15.24]	45 [13.72]	40 [12.19]	35 [10.67]	35 [10.67]	35 [10.67]	35 [10.67]	35 [10.67]	35 [10.67]	35 [10.67]	35 [10.67]	35 [10.67]	35 [10.67]	35 [10.67]	35 [10.67]

NOTES:
 N/R = Application not recommended.
 Grey = This application is acceptable, but the long line guidelines must be followed. Reference Long Line Set section in the I&O

[] Designates Metric Conversions

Refrigerant Line Size Information (con't.)

R-410A System Capacity Model	Vapor Line Connection Size (Inch I.D.) [mm]	Vapor Line Size (Inch O.D.) [mm]	Vapor Line Selection Chart Capacity Multiplier Table													
			Total Equivalent Length - Feet [m]													
			25 [7.62]	50 [15.24]	75 [22.86]	100 [30.48]	125 [45.72]	150 [45.72]	175 [53.34]	200 [60.96]	225 [68.58]	250 [76.20]	275 [83.82]	300 [91.44]		
24	3/4" [19.06]	5/8 [15.88]	0.99	0.99	0.98	0.97	0.96	0.96	0.94	0.93	0.92	0.91	0.9	0.9		
		3/4 [19.05]	1.00	1.00	1.00	0.99	0.99	0.99	0.99	0.99	0.98	0.98	0.98	0.97	0.97	
		7/8 [22.23]	N/R	N/R	N/R	N/R	N/R	N/R	N/R	N/R	N/R	N/R	N/R	N/R	N/R	N/R
		1 [25.4]	N/R	N/R	N/R	N/R	N/R	N/R	N/R	N/R	N/R	N/R	N/R	N/R	N/R	N/R
36	3/4" [19.06]	1-1/8 [28.58]	N/R	N/R	N/R	N/R	N/R	N/R	N/R	N/R	N/R	N/R	N/R	N/R	N/R	
		5/8 [15.88]	0.98	0.96	0.94	0.92	0.9	0.89	0.87	0.85	0.84	0.83	0.84	0.84	0.82	
		3/4 [19.05]	1.00	0.99	0.98	0.98	0.97	0.96	0.95	0.94	0.94	0.94	0.93	0.93	0.92	
		7/8 [22.23]	N/R	N/R	N/R	N/R	N/R	N/R	N/R	N/R	N/R	N/R	N/R	N/R	N/R	N/R
48	3/4" [19.06]	1 [25.4]	N/R	N/R	N/R	N/R	N/R	N/R	N/R	N/R	N/R	N/R	N/R	N/R	N/R	
		1-1/8 [28.58]	N/R	N/R	N/R	N/R	N/R	N/R	N/R	N/R	N/R	N/R	N/R	N/R	N/R	N/R
		5/8 [15.88]	0.99	0.98	0.98	0.96	0.95	0.94	0.93	0.92	0.92	0.91	0.9	0.89	0.88	
		3/4 [19.05]	0.98	0.94	0.91	0.89	0.87	0.84	0.83	0.83	0.81	0.8	0.82	0.81	0.83	
60	3/4" [19.06]	7/8 [22.23]	1.00	0.99	0.99	0.98	0.98	0.97	0.97	0.98	0.97	0.96	0.95	0.95		
		1 [25.4]	N/R	N/R	N/R	N/R	N/R	N/R	N/R	N/R	N/R	N/R	N/R	N/R	N/R	N/R
		1-1/8 [28.58]	N/R	N/R	N/R	N/R	N/R	N/R	N/R	N/R	N/R	N/R	N/R	N/R	N/R	N/R
		5/8 [15.88]	0.99	0.98	0.96	0.95	0.94	0.92	N/R	N/R	N/R	N/R	N/R	N/R	N/R	N/R
	3/4" [19.06]	3/4 [19.05]	0.97	0.93	0.89	0.87	0.84	0.83	N/R	N/R	N/R	N/R	N/R	N/R	N/R	
		7/8 [22.23]	1.00	0.99	0.99	0.98	0.98	0.97	0.97	0.98	0.97	0.96	0.95	0.95		
		1 [25.4]	N/R	N/R	N/R	N/R	N/R	N/R	N/R	N/R	N/R	N/R	N/R	N/R	N/R	N/R
		1-1/8 [28.58]	N/R	N/R	N/R	N/R	N/R	N/R	N/R	N/R	N/R	N/R	N/R	N/R	N/R	N/R

NOTES:
 N/R = Application not recommended.
 All calculations assume a 3/8" liquid line

[] Designates Metric Conversions

Performance Data @ AHRI Standard Conditions – Cooling

High Sales Volume Tested Combination (HSVTC)								
Outdoor Unit	Indoor Coil or Air Handler	Total Capacity BTU/H [kW]	Net Sensible BTU/H [kW]	Net Latent BTU/H [kW]	SEER	EER	Indoor CFM [L/s]	AHRI#
RA2024A	RHVMV2421MEAC	24000 [7.0]	17800 [5.2]	6200 [1.8]	20.5	13.0	825 [389.4]	8852367
RA2036A	RHVMV6021SEAC	36000 [10.6]	27100 [7.9]	8900 [2.6]	20.5	13.0	1225 [578.1]	8852374
RA2048A	RHVMV6021SEAC	46000 [13.5]	34400 [10.1]	11600 [3.4]	21.0	13.0	1550 [731.5]	8852381
RA2060A	RHVMV6024SEAC	57000 [16.7]	40800 [12.0]	16200 [4.7]	20.5	13.0	1650 [778.7]	8852385

R96V: 96% AFUE 2-stage Variable Speed Multipoise Gas Furnace Ratings									
Outdoor Unit	Furnace	Indoor Coil	Total Capacity BTU/H [kW]	Net Sensible BTU/H [kW]	Net Latent BTU/H [kW]	SEER	EER	Indoor CFM [L/s]	AHRI#
RA2024AJV	R96VA0602317M	RCF2421MEA	23800 [7.0]	17600 [5.2]	6200 [1.8]	20.5	13.0	825 [389.4]	8852362
RA2036AJV	R96VA0602317M	RCF6021SEA	36000 [10.6]	27100 [7.9]	8900 [2.6]	20.5	12.5	1200 [566.3]	8852368
RA2024AJV	R96VA0702317M	RCF2421MEA	23600 [6.9]	17200 [5.0]	6400 [1.9]	20.5	13.0	775 [365.8]	8852363
RA2036AJV	R96VA0852521M	RCF6021SEA	36000 [10.6]	27100 [7.9]	8900 [2.6]	20.5	13.0	1225 [578.1]	8852369
RA2036AJV	R96VA1152524M	RCF6021SEA	36000 [10.6]	27100 [7.9]	8900 [2.6]	20.5	13.0	1225 [578.1]	8852370
RA2048AJV	R96VA0852521M	RCF6021SEA	45000 [13.2]	33300 [9.8]	11700 [3.4]	21.0	12.0	1550 [731.5]	8852375
RA2048AJV	R96VA1002521M	RCF6021SEA	44000 [12.9]	30300 [8.9]	13700 [4.0]	21.0	12.5	1225 [578.1]	8852376
RA2048AJV	R96VA1152524M	RCF6021SEA	44500 [13.0]	31500 [9.2]	13000 [3.8]	21.0	13.0	1350 [637.1]	8852377
RA2060AJV	R96VA1152524M	RCF6024MEA	56000 [16.4]	39100 [11.5]	16900 [5.0]	19.5	12.5	1575 [743.3]	8852382

Ratings									
Outdoor Unit	Furnace	Indoor Coil	Total Capacity BTU/H [kW]	Net Sensible BTU/H [kW]	Net Latent BTU/H [kW]	SEER	EER	Indoor CFM [L/s]	AHRI#
RA2024AJV	R97VA060M317U	RCF2421MEA	23800 [7.0]	17600 [5.2]	6200 [1.8]	20.5	13.0	825 [389.4]	8852364
RA2024AJV	R97VA070M317U	RCF2421MEA	23600 [6.9]	17200 [5.0]	6400 [1.9]	20.5	13.0	775 [365.8]	8852365
RA2036AJV	R97VA060M317U	RCF6021SEA	36000 [10.6]	27100 [7.9]	8900 [2.6]	20.5	12.5	1200 [566.3]	8852371
RA2036AJV	R97VA085M521U	RCF6021SEA	36000 [10.6]	27100 [7.9]	8900 [2.6]	20.5	13.0	1225 [578.1]	8852372
RA2036AJV	R97VA115M524U	RCF6021SEA	36000 [10.6]	27100 [7.9]	8900 [2.6]	20.5	13.0	1225 [578.1]	8852373
RA2048AJV	R97VA085M521U	RCF6021SEA	45000 [13.2]	33300 [9.8]	11700 [3.4]	21.0	12.0	1550 [731.5]	8852378
RA2048AJV	R97VA100M521U	RCF6021SEA	44000 [12.9]	30300 [8.9]	13700 [4.0]	21.0	12.5	1225 [578.1]	8852379
RA2048AJV	R97VA115M524U	RCF6021SEA	44500 [13.0]	31500 [9.2]	13000 [3.8]	21.0	13.0	1350 [637.1]	8852380
RA2060AJV	R97VA115M524U	RCF6024MEA	56000 [16.4]	39100 [11.5]	16900 [5.0]	19.5	12.5	1575 [743.3]	8852383

[] Designates Metric Conversions

GUIDE SPECIFICATIONS

General

System Description

Outdoor-mounted, air-cooled, split-system air conditioner composite base pan unit suitable for ground or rooftop installation. Unit consists of a hermetic compressor, an air-cooled coil, forward swept blade propeller-type condenser fan, suction and legend line service valve, and a control box. Unit will discharge supply air upward as shown on contract drawings. Unit will be used in a refrigeration circuit to match up to a coil unit.

Quality Assurance

- Unit will be rated in accordance with the latest edition of AHRI Standard 210.
- Unit will be certified for capacity and efficiency, and listed in the latest AHRI directory.
- Unit construction will comply with latest edition of ANSI/ASHRAE and with NEC.
- Unit will be constructed in accordance with UL standards and will carry the UL label of approval. Unit will have c-UL-us approval.
- Unit cabinet will be capable of withstanding ASTM B117 1000-hr salt spray test.
- Air-cooled condenser coils will be leak tested at 150 psig and pressure tested at 550 psig.
- Unit constructed in ISO9001 approved facility.

Delivery, Storage, and Handling

- Unit will be shipped as single package only and is stored and handled per unit manufacturer's recommendations.

Warranty (for inclusion by specifying engineer) – U.S. and Canada only.

Products

Equipment

Factory assembled, single piece, air-cooled air conditioner unit. Contained within the unit enclosure is all factory wiring, piping, controls, compressor, refrigerant charge R-410A, and special features required prior to field start-up.

Unit Cabinet

- Unit cabinet will be constructed of galvanized steel, bonderized, and coated with a powder coat paint.
- All units constructed with louver coil protection and corner post. Louver can be removed by removing one fastener per louver panel.

AIR-COOLED, SPLIT-SYSTEM AIR CONDITIONER

RA20

1-1/2 TO 5 NOMINAL TONS

Fans

- Condenser fan will be direct-drive propeller type, discharging air upward.
- Condenser fan motors will be totally enclosed, 1-phase type with class B insulation and permanently lubricated bearings. Shafts will be corrosion resistant.
- Fan blades will be statically and dynamically balanced.
- Condenser fan openings will be equipped with coated steel wire safety guards.

Compressor

- Compressor will be hermetically sealed.
- Compressor will be mounted on rubber vibration isolators.
- Compressor will be covered with a sound absorbing blanket.

Condenser Coil

- Condenser coil will be air cooled.
- Coil will be constructed of aluminum fins mechanically bonded to copper tubes.

Refrigeration Components

- Refrigeration circuit components will include liquid-line shutoff valve with sweat connections, vapor-line shutoff valve with sweat connections, system charge of R-410A refrigerant, and compressor oil.
- Unit will be equipped with filter drier for R-410A refrigerant for field installation.

Operating Characteristics

- The capacity of the unit will meet or exceed _____ Btuh at a suction temperature of _____ °F/°C. The power consumption at full load will not exceed _____ kW.
- Combination of the unit and the evaporator or fan coil unit will have a total net cooling capacity of _____ Btuh or greater at conditions of _____ CFM entering air temperature at the evaporator at _____ °F/°C wet bulb and _____ °F/°C dry bulb, and air entering the unit at _____ °F/°C.
- The system will have a SEER of _____ Btuh/watt or greater at DOE conditions.

Electrical Requirements

- Nominal unit electrical characteristics will be _____ v, single phase, 60 hz. The unit will be capable of satisfactory operation within voltage limits of _____ v to _____ v.
- Nominal unit electrical characteristics will be _____ v, three phase, 60 hz. The unit will be capable of satisfactory operation within voltage limits of _____ v to _____ v.
- Unit electrical power will be single point connection.
- Control circuit will be 24v.

Special Features

- Refer to section of this literature identifying accessories and descriptions for specific features and available enhancements.
- EcoNet control with appropriate software version is required for full featured operation.

GENERAL TERMS OF LIMITED WARRANTY*

Rheem will furnish a replacement for any part of this product which fails in normal use and service within the applicable period stated, in accordance with the terms of the limited warranty.

***For complete details of the Limited and Conditional Warranties, including applicable terms and conditions, contact your local contractor or the Manufacturer for a copy of the product warranty certificate.**

Conditional Unit Replacement
(Registration Required) Ten (10) Years
Parts Ten (10) Years



The new degree of comfort.™

In keeping with its policy of continuous progress and product improvement, Rheem reserves the right to make changes without notice.

Rheem Heating, Cooling & Water Heating • P.O. Box 17010
Fort Smith, Arkansas 72917 • www.rheem.com

Rheem Canada Ltd./Ltée • 125 Edgeware Road, Unit 1
Brampton, Ontario • L6Y 0P5



INTEGRATED HOME COMFORT

PRINTED IN U.S.A. 2/16 QG FORM NO. A11-224